



# The Konftel 55 User Guide

ENGLISH

## OmniSound® HD – superior sound quality

The patented OmniSound® audio technology guarantees an impressive and crystal-clear full-duplex audio, allowing you to speak in two directions for effective participation in virtual meetings. The sound is transmitted clearly and powerfully to all attendees thanks to a hypersensitive microphone with 360° audio pick-up and speakers.

OmniSound® HD delivers HD audio during VoIP calls. It also incorporates automatic echo cancellation and noise suppression, which minimises background noise interference, and an equaliser for personal adaptation of the audio properties. This means you can move about freely in the room, talking, discussing and debating with others without any loss of audio quality and without any annoying sound clipping, damping or echoes. It's as close to real sound as you can get.



Konftel AB hereby declares that this conference phone is in conformity with all the essential requirements and other relevant provisions of Directive 1999/5/EC.

Please visit [www.konftel.com/doc](http://www.konftel.com/doc) to read the declaration in its entirety.



### **Warning!**

Do not expose the Konftel 55 to water or moisture.



### **Warning!**

Do not open the casing of the Konftel 55.



### **Warning!**

Only use the power adapter provided to connect the unit to the mains.

# CONTENTS

<b>Introduction</b>	<b>2</b>
Maintenance .....	2
<b>Description</b>	<b>3</b>
General.....	4
Bridge connection.....	5
Battery .....	6
<b>Using the Konftel with a desktop phone</b>	<b>7</b>
Connecting to a desktop phone .....	7
Making calls.....	8
<b>Using the Konftel with a mobile phone</b>	<b>9</b>
Cable connection to a mobile phone .....	9
Making calls.....	10
<b>Using the Konftel with a computer</b>	<b>11</b>
Connection to a computer.....	11
Using the Konftel with a computer .....	12
<b>Bridge connection</b>	<b>13</b>
Adjusting the volume.....	13
<b>Using a headset</b>	<b>15</b>
<b>Recorder capability</b>	<b>16</b>
Recording .....	16
Listening to a recording.....	17
<b>Settings</b>	<b>18</b>
Changing languages .....	18
Adjusting sound effects.....	19
Changing connection settings .....	20
Changing system settings .....	23
<b>Upgrading software</b>	<b>24</b>
Upgrading from a PC.....	24
Upgrading via an SD card .....	25
<b>Technical data</b>	<b>26</b>

# INTRODUCTION

The Konftel 55 is a conference unit that can be connected to your desktop phone, your mobile phone and your computer to obtain crystal-clear, powerful OmniSound® HD audio in your virtual meetings.

- OmniSound® HD audio technology with full duplex, echo cancellation and static reduction in full bandwidth (20–24000Hz). (The telecommunications network technology limits the bandwidth when communicating via the telecommunications network.)
- LCD high-resolution display with touch buttons, where the interface changes according to the connections you make.
- Mobile phone connection via a mobile cable (accessory).
- Connection to a desktop phone via a Konftel desk phone adapter (accessory) which makes it easy to move the sound between the handset and conference phone.
- USB connection to a computer or another USB device that supports handsfree connection.
- Automatic detection of USB playback/VoIP calls, which means that the OmniSound® HD audio processing feature only processes the sound when necessary. The sound is not altered when music is played.
- Audio bridge capability between a computer and connected phone.
- Call recorder capability allows you to listen to meetings afterwards or use the Konftel 55 as a dictaphone.
- Battery-powered option. The battery can be charged via the mains supply (power adapter provided) and USB.
- Headset connectivity option allows easy switching between headset and speaker function.
- Upgradeable.
- Two-year warranty.

## MAINTENANCE

Clean the equipment with a soft, dry cloth. Never use liquids.

# DESCRIPTION

## On/Off/Power save mode

Long press On/off  
Short press Turns screen off

Mute (microphone off / speaker off)

Touch screen

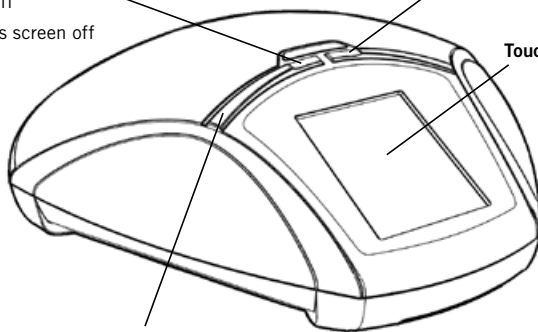

## LEDs

Steady blue light	Sound channel on/call in progress
Steady red light	Mute, microphone turned off
Flashing red	Hold, microphone and speaker turned off

## Battery cover

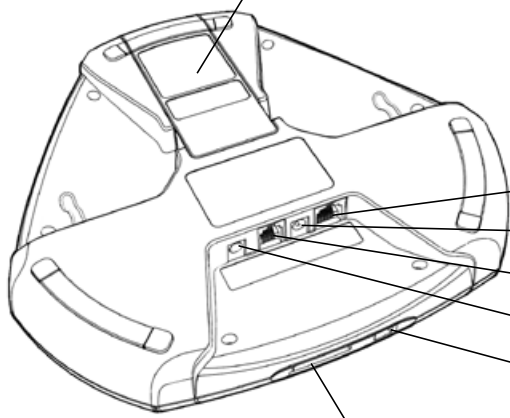

## Connections:

Desk phone adapter  
Power supply  
Mobile phone  
Headset (3.5 mm)  
Computer (mini USB)

SD memory card port

# DESCRIPTION

## GENERAL

The Konftel 55 automatically detects the connections you make. Despite the unit's multiple connectivity options, it is simple to use and understand because it only displays the buttons that can be used in that particular situation.

The first time the Konftel 55 is started up, the display only shows a menu button. If you connect to a computer via USB, a button for this is displayed so that you can easily turn the sound on and off. Similarly, a desktop button is displayed if you connect a desktop phone, a headset button if you connect a headset and a record button if you insert an SD memory card.

A lit button indicates that the feature is active. When you press the button, it switches between on and off.



## LEDs

When a mobile or desktop phone button is activated, the blue LEDs light up too, indicating that an audio channel is open. This does not necessarily mean that a call is in progress since the call is controlled from the connected device (the mobile or desktop phone).



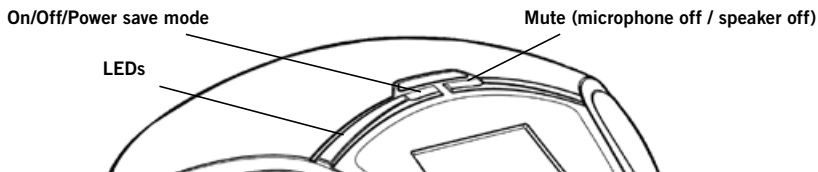

You can move the sound between the Konftel 55 and the phone during a call by pressing the button (📞 or 🖨️) on the Konftel 55.

With a computer connection, the LEDs first light up when a communication program that uses the microphone starts.

# DESCRIPTION





## Mute button



- ⇒ Press the button  (the actual button on the right) to turn the microphone off during a call.  
*The LEDs show a steady red light and two buttons are displayed.*
- ⇒ Press the   button if you also want to turn the speaker off.  
*The LEDs flash red.*
- ① Note that the buttons on the screen disappear after 5 seconds or if you touch the screen outside the buttons.
- ⇒ Press  once again (the actual button on the right or the button on the screen) to turn the microphone (and speaker) on.  
*The LEDs show a steady blue light.*

## Power save mode

The Konftel 55 has several power save mode levels. After five minutes, the background lighting fades and after 15 minutes the image on the screen is replaced by a clock. Less time if running on battery power. The display can also be turned off manually.

- ⇒ Press the button  (the actual button on the left) to turn the display off.
- ⇒ Press the display or the button  to restore full brightness if power save mode has turned off the display.

## Switching off

- ⇒ Hold down the button  (the actual button on the left) for three seconds.
- ⇒ Confirm that you want to switch off the Konftel 55 by pressing .

## BRIDGE CONNECTION

It is possible to establish an audio conference bridge between a connected phone and the computer. This means that you can make a call with your connected mobile or desktop phone and combine it with, for example, a Skype® call on the computer.

Audio bridge combinations other than a phone and computer are not possible.

Find out more about audio bridging on page 13.

## BATTERY

The battery is charged in the Konftel 55, either via the power adapter provided or via USB. It takes about 4 hours to fully charge an empty battery using the power adapter and about 5 hours via USB.

- ① The Konftel 55 has to be connected to a USB port that produces power (e.g. on a computer) in order to charge the battery. Note that it takes much longer to charge via USB if the Konftel 55 is turned off.

### Inserting a battery

- ⇒ Push the battery cover forwards to remove it.
- ⇒ Insert the battery in the Konftel 55 with its contacts towards the pins in the bottom of the battery compartment.

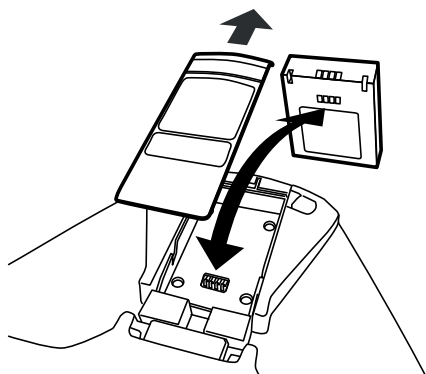

- ⇒ Slide the battery cover back into place.



# USING THE KONFTEL WITH A DESKTOP PHONE

The Konftel 55 transforms your desktop phone to a conference phone with OmniSound® HD. Unlike the integrated speaker function of many desktop phones, you enjoy a high sound level, full duplex (two-way audio) and efficient echo cancellation and static reduction.

- ① OmniSound® HD performs over the full audio bandwidth (100–24000 Hz) but the technologies in today's telecommunications networks do not allow the full bandwidth to be used. This has an effect on the sound quality.

The Konftel 55 is connected using a desk phone adapter (accessory) which is installed between the phone and handset. The adapter allows you to transfer calls between the Konftel 55 and the handset by pressing a button.

The Konftel 55 can be connected to all digital phones (corporate networks) and, in many cases, to analogue phones too (traditional telephone sockets in the home).

- ① Note that some desktop phones can also be connected via their headset jack. See "Using the Konftel with a mobile phone" on page 9.

## CONNECTING TO A DESKTOP PHONE

- ⇒ Unplug the telephone handset cable from the phone and connect it to the desk phone adapter.
- ⇒ Connect the desk phone adapter to the phone and the Konftel 55 as illustrated below.  
*The  button is displayed on the Konftel 55.*

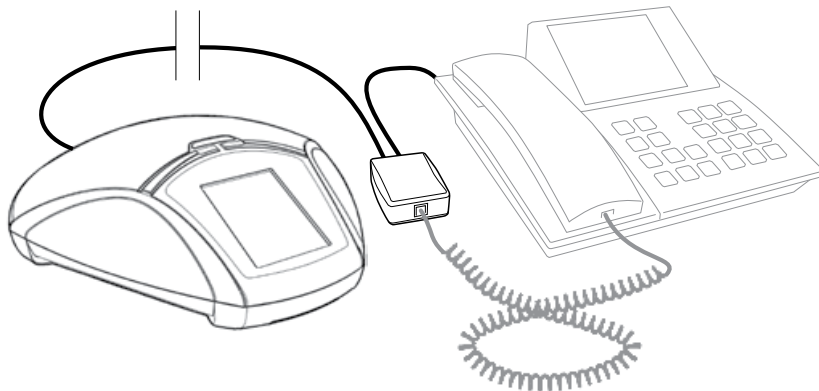

- ⇒ Make a test call to check that the receiving party has a good sound level (see page 20).
- ① The sound level produced by phones varies between the different makes. The Konftel 55's microphone level may therefore need adjusting to ensure good sound quality for the other call participants. The setting is saved in the Konftel 55 and is used each time a phone is connected via the adapter.

## MAKING CALLS

You can make a call with the phone as usual and then transfer the call to the Konftel 55, or transfer the sound before the call is connected.

⇒ Press the  button on the Konftel 55 to transfer the sound from the phone to the Konftel 55.

*The  button and the LEDs light up.*



⇒ Lift the handset and dial the number on the desktop phone.

### Adjusting the volume

The volume can be adjusted when the phone is active ( is lit up). As is the practice in the context of telephone communications, it is not possible to turn the sound off completely using the volume control.

### Transferring and ending calls

⇒ Press  to transfer the sound between the Konftel 55 and the phone's handset.

⇒ End the call by placing the handset back on the desktop phone.

① The  button on the Konftel 55 can remain lit if you want to use the Konftel 55 for future calls too.

# USING THE KONFTEL WITH A MOBILE PHONE

The Konftel 55 transforms your mobile phone to a conference phone with OmniSound® HD, ensuring high sound level, full duplex (two-way audio) and efficient echo cancellation and static reduction.

- ① OmniSound® HD performs over the full audio bandwidth (100–24000 Hz), but limitations in mobile telecommunications networks reduce the bandwidth somewhat and the sound is compressed. This has an effect on the sound quality. Calls via updated 3G networks are more likely to have good audio quality.
- ① Note that it is not possible to use a desktop phone and a mobile phone at the same time with the Konftel 55. The desktop phone connection is disabled when the mobile phone is connected.

## CABLE CONNECTION TO A MOBILE PHONE

The Konftel 55 is connected using a cable which is adapted for your phone (optional accessory). The Konftel 55 works in the same way as a headset connected to the mobile phone.

- ① Note that some desktop phones can also be connected via their headset jack. The function is exactly the same as for a mobile phone connection and we only write "mobile phone" in the description.
- ⇒ Connect the phone to the Konftel 55 using the mobile phone cable.  
*The  button is displayed on the Konftel 55. The button is immediately activated on connection.*
- ⇒ Make a test call to check that the receiving party has a good sound level. See page 21.
- ① The sound level produced by phones varies between the different makes. The Konftel 55's microphone level may therefore need adjusting to ensure good sound quality for the other call participants. The setting is saved in the Konftel 55 and is used each time a phone is connected via a mobile cable.

### Automatic detection of mobile phone

The Konftel 55 can normally detect when a mobile phone is connected via a cable. Some mobile phones do not activate the connection until a call is connected or they put the connection to the Konftel 55/headset to sleep after a certain period of inactivity. If this is the case, the  button will not be displayed until you make a call from your mobile or receive an incoming call.

If you want  to be visible all the time and your mobile phone does not automatically activate the connection, you can change the setting so that the button is always displayed, whether or not your mobile phone is connected (see page 20).

## MAKING CALLS

- ⇒ Check that the  button on the Konftel 55 is lit up blue. If it is not lit up, press the button.
- ⇒ Dial the number on the mobile phone.
- ① If you have a call in progress on your mobile and want to transfer it to the Konftel 55, simply connect the cable.



## Adjusting the volume

The volume can be adjusted when the phone is active ( is lit up). As is the practice in the context of telephone communications, it is not possible to turn the sound off completely using the volume control.

## Hold

- ⇒ Press  to put the call on hold (microphone and speaker turned off).

## Transferring calls

- ⇒ Remove the cable from the mobile phone to transfer the sound from the Konftel 55 to the phone.

## Ending calls

- ⇒ End the call on the mobile phone.
- ① The  button on the Konftel 55 can remain lit if you want to use the Konftel 55 for future calls too.

# USING THE KONFTEL WITH A COMPUTER

The Konftel 55 transforms your computer to teleconferencing equipment with OmniSound® HD. Unlike normal computer speakers and microphones, the Konftel 55 provides full duplex (two-way audio) and efficient echo cancellation and static reduction. The computer identifies the Konftel 55 as an echo cancellation device which means that communication software usually leaves the audio processing to the Konftel 55, resulting in better sound quality. This can also be manually adjusted, for example in Skype®.

- ① OmniSound® HD performs over the full audio bandwidth (100–24000 Hz), but depending on the equipment in the network and equipment used by the other call participants, there may be some factors that limit the sound quality.

## CONNECTION TO A COMPUTER

⇒ Connect the computer to the Konftel 55 using the USB cable provided.

*The  button is displayed on the Konftel 55. The button is immediately activated on connection.*

- ① The computer's operating system normally automatically selects the Konftel 55 as a speaker and microphone. If the Konftel 55 is not automatically selected as an audio device in the computer, you may have to open the computer's settings and select **Konftel 55**.
- ① If you have an active software program in the computer that is using the computer's built-in speakers, it may be necessary to restart the program to switch to the new speaker (Konftel 55).

## USING THE KONFTEL WITH A COMPUTER

### Using as a computer speaker

USB is immediately activated on connection (💻 lights up).



The computer normally only activates the speaker in the Konftel 55 if there is no other program running that can use the microphone. This means that the Konftel 55 acts as a computer speaker and that the audio processing in OmniSound® HD is turned off so that the sound is not altered.

### Using the Konftel as a conference unit

When communication software or audio recording software is started on the computer, the Konftel 55 microphone is also activated. OmniSound® is now handling full duplex and echo cancellation. The blue LEDs on the Konftel 55 also light up at the same time.

To make a VoIP call, use Skype®, Microsoft Lync®, an online meeting service or some other VoIP (Voice over IP) software.



### Adjusting the volume

The volume of the computer and the Konftel 55 can be adjusted.

① Press the 💻 button on the Konftel 55 to turn the sound off quickly.

# BRIDGE CONNECTION

When bridging a computer and a phone, all you need to do is activate both sources of sound. OmniSound® HD can handle full duplex, echo cancellation and static reduction for both the sound sources simultaneously.

⇒ Press  and (depending on which phone is connected) press  or .

*Both buttons are lit up and the sound from the computer and phone is audible from the Konftel 55.  
The volume control gets two level indicators.*



## ADJUSTING THE VOLUME

The general sound level for the call is adjusted in the normal way by pressing on the right or left-hand side of the volume button.

### Adjusting the level of each sound source individually

The sound from the computer and your phone can have different levels. If each sound source is adjusted individually, all the voices in a call will be heard clearly.

⇒ Press the button on the top of the volume control.

*The volume control is divided into two volume controls.*



## BRIDGE CONNECTION

- ⇒ Adjusting the sound individually for each sound source.
- ⇒ Return to just one volume control by pressing the button on the top of the upper volume control.
- ① The Konftel 55 saves the set level when a sound source is turned off. The next time the same sound source is activated, it is started at the most recently used volume.



# USING A HEADSET

The Konftel 55 has a headset port (3.5 mm plug).

- ① See the heading Headset under settings (page 21) if your headset does not work with the Konftel 55.
- ① There is also a headset sound level setting, which allows the level of sound to be adjusted so that it seems as powerful as from the speakers.





## Warning!

Use of headphones/earbuds at high volumes can damage your hearing.

- ⇒ Connect your headset to the Konftel 55.

*The  button is displayed on the Konftel 55.*

- ⇒ Press . Connect your headset to the Konftel 55.

*The  button lights up and the sound is transferred from the Konftel 55 to the connected headset.*



# RECORDER CAPABILITY

The Konftel 55 can be used to record your meetings and for dictations. The recordings are saved on a memory card. Folders are automatically created on the card with the date of the recordings. These are saved in WAV format with the time when the recording started. The Konftel 55 supports SD and SDHC cards. Recording capacity is 35 hours per GB on the memory card.

## RECORDING

- ① Always make sure that the conference call participants do not object to a meeting being recorded. The participants you call will hear an audible signal at regular intervals to let them know that the call is being recorded.
- ⇒ Inserting an SD memory card in the Konftel 55.

*The right-hand side of the **≡ MENU** button is a recording button ●.*

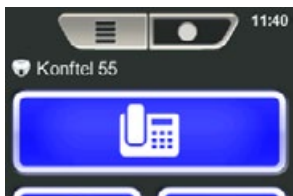

- ⇒ Press ● to start recording.

*The recording button flashes red and the recorded time is displayed.*



- ⇒ Press the recording button ● again to stop recording.

*The recording is saved on the SD card.*

## LISTENING TO A RECORDING

You can transfer the card to a computer to play back and edit the recording, or you can play it back on the Konftel 55.

⇒ Press **MENU** and select **Recordings**.

*A list of the recordings on the SD card is displayed.*



⇒ Press the recording you want to listen to.

You can pause the playback by pressing **||** and move forwards and backwards 10 seconds by pressing **▶** and **◀**.

You can move to any part of the recording you like by pressing on the time line above the buttons.

Adjust the sound level using the buttons **◀** and **▶**.

# SETTINGS

⇒ Press **≡ MENU**.

*The menu opens.*



## CHANGING LANGUAGES

⇒ Press **Language** in the menu.

⇒ Select a language from the list and press the back arrow **←**.



## ADJUSTING SOUND EFFECTS

- ⇒ Press 🎵 Sound in the menu.
- ⇒ Make your settings by pressing the buttons and end with the back arrow ←.

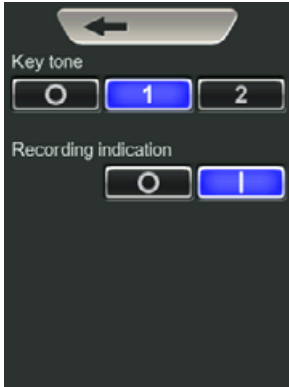

### Keypad tone

There is a choice of off, discreet and a slightly louder click sound.

### Recording indicator

To let people know that a call is being recorded when you call them, an audible signal is heard at regular intervals. This recording indicator can be turned off.

## CHANGING CONNECTION SETTINGS

- ⇒ Press  Connection in the menu.
- ⇒ Make your settings by pressing the buttons and end with the back arrow ←.



### Connecting a mobile phone

The Konftel 55 can normally detect when a mobile phone is connected via a cable. Some mobile phones do not activate the connection until a call is connected. If the mobile phone that is connected is like this and you want the sound activation button on the Konftel 55 to be visible all the time, you should select I instead of **Auto**.

### Desk phone adapter configuration

 This setting is only shown if a phone adapter is connected.

The telephone manufacturers have different ways of using the pins in the phone handset connectors. If the adapter does not work with your phone, you may need to change the configuration of the pins by moving this setting from 1 to 2.

- ⇒ Activate  and lift the handset of you connected phone to check if the phone adapter is working.

*You should hear the connection tone in the Konftel 55.*



### Desk phone adapter microphone level

 This setting is only shown if a phone adapter is connected.

The level of sound sent by phones to the receiving party varies between the different makes. It may be necessary to adapt the microphone level to the telephone in order to adapt this sound level so that the Konftel 55 provides optimal performance and the other participants enjoy quality sound.

# SETTINGS

The setting is saved in the Konftel 55 and is used each time a phone is connected via the phone adapter.

- ⇒ Activate  and make a test call with your phone.
- ⇒ Open the  **Connection** setting in the menu and adjust the outgoing sound until you find the optimal level.

① When speaking directly into your phone, use the sound as a reference level.

If the other party finds it hard to hear the sound, try increasing the level of the outgoing sound from 0 to +1 or +2.

If the other party finds the sound loud but distorted, try decreasing the level of the outgoing sound from 0 to -1 or -2.



## Mobile phone microphone level

① This setting is only shown if a mobile phone is connected with a cable.

The level of sound sent by mobile phones to the receiving party varies between the different makes. It may be necessary to adapt the microphone level to the mobile telephone in order to adapt this sound level so that the Konftel 55 provides optimal performance and the other participants enjoy quality sound.

The setting is saved in the Konftel 55 and is used next time a mobile phone is connected. Note that since the levels can vary from one make to another, it may be necessary to make a new adjustment when other mobile phones are connected.

① The basic setting 0 works satisfactorily for most mobile phones, but this setting allows you to fine tune the sound.

- ⇒ Activate  and make a test call with your mobile phone connected to the Konftel 55.
- ⇒ Open the  **Connection** setting in the menu and adjust the outgoing sound until you find the optimal level.

① When speaking directly into your mobile phone, use the sound as a reference level.

If the other party finds it hard to hear the sound, try increasing the level of the outgoing sound from 0 to +1 or +2.

If the other party finds the sound loud but distorted, try decreasing the level of the outgoing sound from 0 to -1 or -2.

## Headsets

This setting allows you to adapt the headset port for different headsets.

Most headsets with a 3.5 mm plug have three (mono) or four (stereo) interfaces with the microphone's connector furthest out on the top. If your headset does not work, it may be because it has another position on the interfaces.

## Headset level

Sensitivity (audio volume) can vary from headset to headset. It is therefore possible to adjust the volume so that the sound heard seems to be about the same level as when heard via the speakers.



### **Warning!**



Use of headphones/earbuds at high volumes can damage your hearing.

A higher volume may be harmful to hearing if you have a high-sensitivity headset.

- ① Note that for safety reasons, this setting is reset when you remove your headset. This is because another headset that is connected may be more sensitive.



## CHANGING SYSTEM SETTINGS

- ⇒ Press the  System button on the menu.
- ⇒ Make your settings by pressing the buttons and end with the back arrow .



Here you can:

- Change the name of your Konftel 55
- Set the time and date for recordings
- Check software versions
- Initiate software upgrades
- Restore your Konftel 55 to factory settings, thereby deleting all settings and saved values.

# UPGRADING SOFTWARE

The Konftel 55 is continually being developed with smart features and the software can be upgraded to ensure the unit is always running the latest software version. You can upgrade via a USB or via an SD card.

- ① Note that in upgrade mode, the text is always in English whatever language has been selected in the the Konftel 55. The same applies to the software **Konftel Upgrade Utility**.

## UPGRADING FROM A PC

This method requires a PC with Microsoft® Windows®.

### Installing Konftel Upgrade Utility

- ⇒ Visit [www.konftel.com/upgrades](http://www.konftel.com/upgrades) and select Konftel 55.
- ⇒ Download **Konftel Upgrade Utility**.
- ⇒ Install the software on your computer.  
Follow the instructions given by the installation program.

### Updating software

- ⇒ Connect your Konftel 55 to the computer using the USB cable.
- ⇒ Press **MENU**, select **System**.
- ⇒ Press the **Upgrade** button and confirm by pressing **✓** to reboot in upgrade mode.



*The Konftel 55 restarts in upgrade mode.*

- ⇒ Press **Use USB** when the Konftel 55 reboots.
- ⇒ Start **Konftel Upgrade Utility** on your computer.  
Follow the instructions that the software guide gives you.

# UPGRADING SOFTWARE

- ① We recommend that you let Konftel Upgrade Utility automatically download and install the latest version from Konftel's website. You can also install a Konftel firmware file that has already been downloaded to the PC's hard drive.

## UPGRADING VIA AN SD CARD

This method requires a PC with an SD card reader.

### Downloading upgrade files

- ⇒ Visit [www.konftel.com/upgrades](http://www.konftel.com/upgrades) and select Konftel 55.
- ⇒ Download the latest software version for the Konftel 55/55W.
- ⇒ Copy the file (with .kt extension) to an SD card.

### Updating software

- ⇒ Insert the SD card with the software file in the Konftel 55.
- ⇒ Press **MENU**, select **System**.
- ⇒ Press the **Upgrade** button and confirm by pressing **✓** to reboot in upgrade mode.



*The Konftel 55 restarts in upgrade mode.*

- ⇒ Press **50** **Use USB** when the Konftel 55 reboots.
- ⇒ Follow the instructions that are displayed on the Konftel 55.

# TECHNICAL DATA

Size	Width 222 mm, depth 206 mm, height 68 mm.
Weight	640 g.
Colour	Liquorice black and silver.
Display	Colour LCD, 240x320 pixels.
Buttons	Touch screen plus on/off and microphone switch-off.
Memory	SD (SDHC) memory card support.
Upgrading	Konftel upgrade utility (for Microsoft Windows) upgrades Konftel 55 software via the USB connection. It is also possible to upgrade via an SD card.

## Power supply

AC adapter	Phihong PSC12R, 100–240 V AC/12 V DC.
------------	---------------------------------------

## Connectivity

USB	USB 2.0 Mini B. For computer connection.
Mobile phone	Modular 6P6C DEC. For connection to headset jack (optional cable required).
Desktop phone	Modular 8P8C. For connection to an IP or TDM desktop phone using a Konftel phone adapter (optional). Some desktop phones can be connected directly to the phone with a special cable.
Headsets	3.5 mm phone plug (TRS/TRRS).

## Sound

Technology	OmniSound® HD.
Microphone	Omnidirectional.
Coverage range	Up to 30 m <sup>2</sup> .
Frequency range	100-24000 Hz.
Volume	90 dB SPL 0.5 m.

## Environment

Temperature	5°–40°C.
Relative humidity	20-80% condensation free.
Recommended acoustics	Reverberation period 0.5 S Rt 60. Background noise < 45 dBA.

Konftel is a leading company and the world's fastest growing brand, within audio conferencing equipment. Since 1988, our mission has been to help people around the world to conduct meetings despite distances. Based on our success, we know that audio conferencing is a great way to save time, money and at the same time contribute to a better environment. High audio quality is essential for efficient meetings, this is why our patented audio technology OmniSound<sup>®</sup>, is built into all Konftel Conference phones. The products are sold globally under the Konftel brand and our head-quarter is based in Sweden. Read more about the company and products on **[www.konftel.com](http://www.konftel.com)**



**Head office:** Konftel AB, Box 268, 901 06 Umeå, Sweden  
Tel: +46 (0)90-70 64 89, Fax: +46 (0)90-13 14 35, [info@konftel.com](mailto:info@konftel.com) [www.konftel.com](http://www.konftel.com)